

DRAWER / CASSETTO / CAJÓN / TIROIR / GAVETA / SZUFLADA

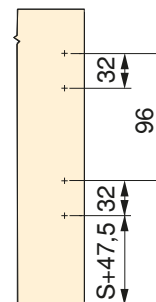

S: Overlay / Sormonto / Solape / Recouvrement / Sobreposição da ilharga / Nałożenie

## DRAWER / CASSETTO / CAJÓN / TIROIR / GAVETA / SZUFLADA

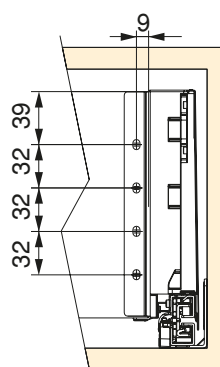
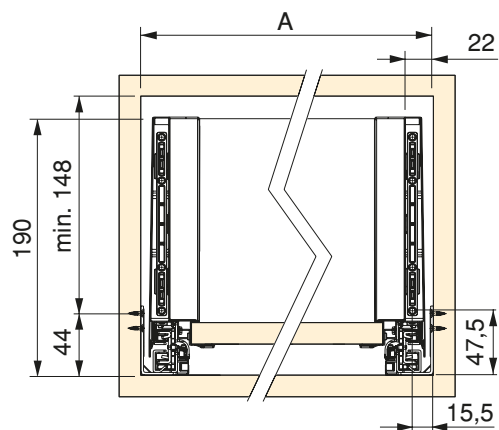
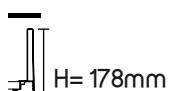
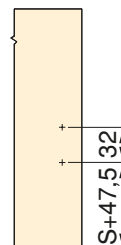
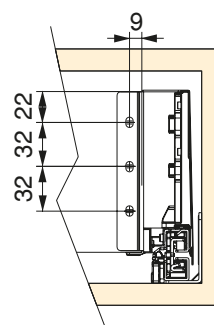
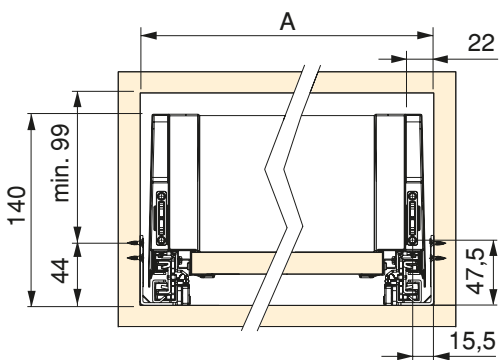
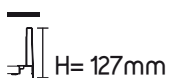
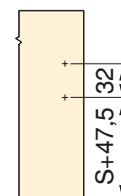
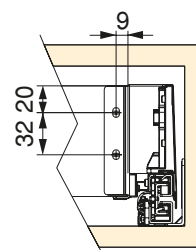
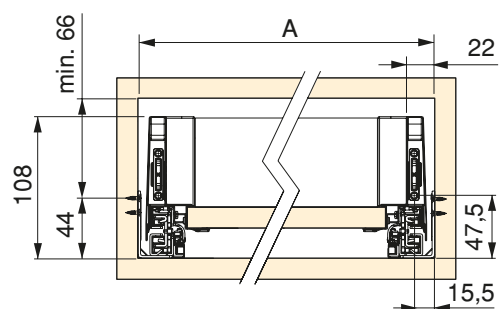
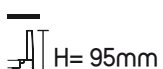
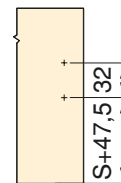
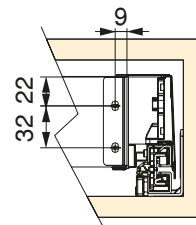
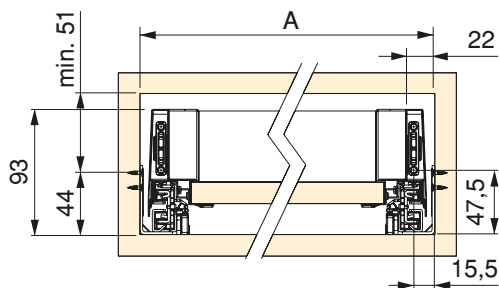
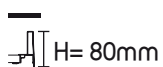
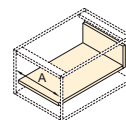

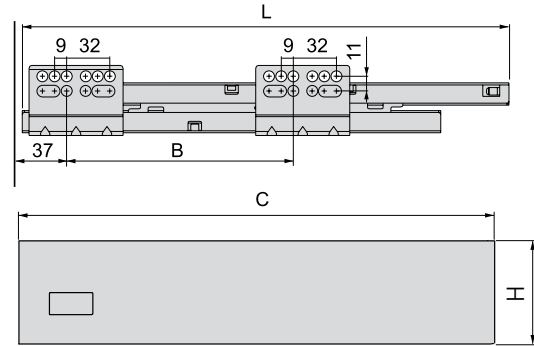
H	Prof.	L	B	C
80 95 127 178	270	265	96	267
	300	295	128	297
	350	345	128	347
	400	395	192	397
	450	445	224	447
	500	495	224	497

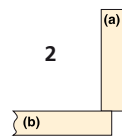
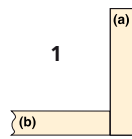
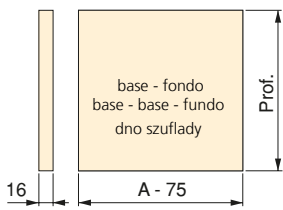

## BOTTOM LENGHT - LUNGHEZZA FONDO - LONGITUD FONDO - LONGUEUR DU FOND DE TIROIR - COMPRIMENTO FUNDO - GŁĘBOKOŚĆ





(a): back plate - schiena - trasera - façade - traseira - płyta tylna  
 (b): base - fondo - base - base - fundo - dno szuflady

Option - Opzione - Opción Option - Opção - Opcja	
	
Prof. - 24	Prof. - 20*

- \* Option to assembly wood or aluminum back panel.
- \* Opzione per montaggio di schiena legno o alluminio.
- \* Opción para montaje de trasera madera o aluminio.
- \* Option pour montage façade arrière bois ou en aluminium.
- \* Opção para montagem de traseira madeira ou alumínio.
- \* Opcja montażu drewnianego tyłu lub z aluminium.

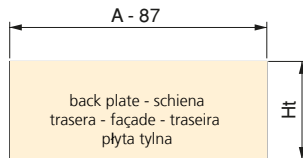
## DRAWER PANEL HEIGHT - ALTEZZA SCHIENA - ALTURA TRASERA - HAUTEUR FAÇADE ARRIÈRE - ALTURA TRASEIRA - WYSOKOŚĆ TYŁU



H	Option - Opzione - Opción Option - Opção - Opcja	
		
80	Ht 69	Ht 53
95	84	68
127	116	100
178	167	151

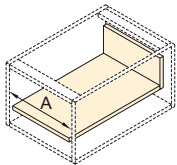

Inner drawer  
 Cassetto interno  
 Cajón interior  
 Tiroir intérieur  
 Gaveta interior  
 Szuflady wewnętrznej

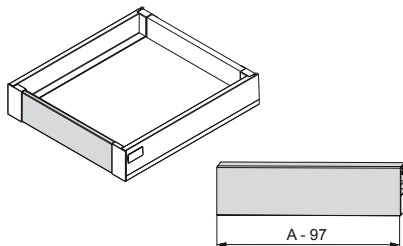

Frontal railing for inner drawer  
 Astina frontale per cassetto interno  
 Barandilla frontal para cajón interior  
 Rehausse frontale pour tiroir intérieur  
 Cerco frontal para gaveta interior  
 Reling frontowy

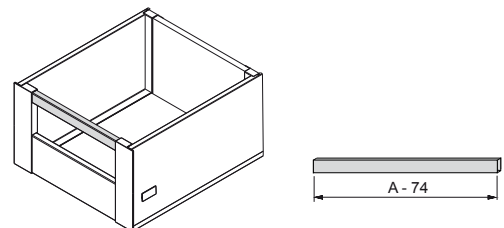

A: Inner module / Interno modulo / Interior módulo / Interieur caisson  
 Interior de módulo / Szuflada wewnętrzna

DRAWER / CASSETTO / CAJÓN / TIROIR / GAVETA / SZUFLADA

H= 80mm

H= 95mm

H= 127mm

H= 178mm

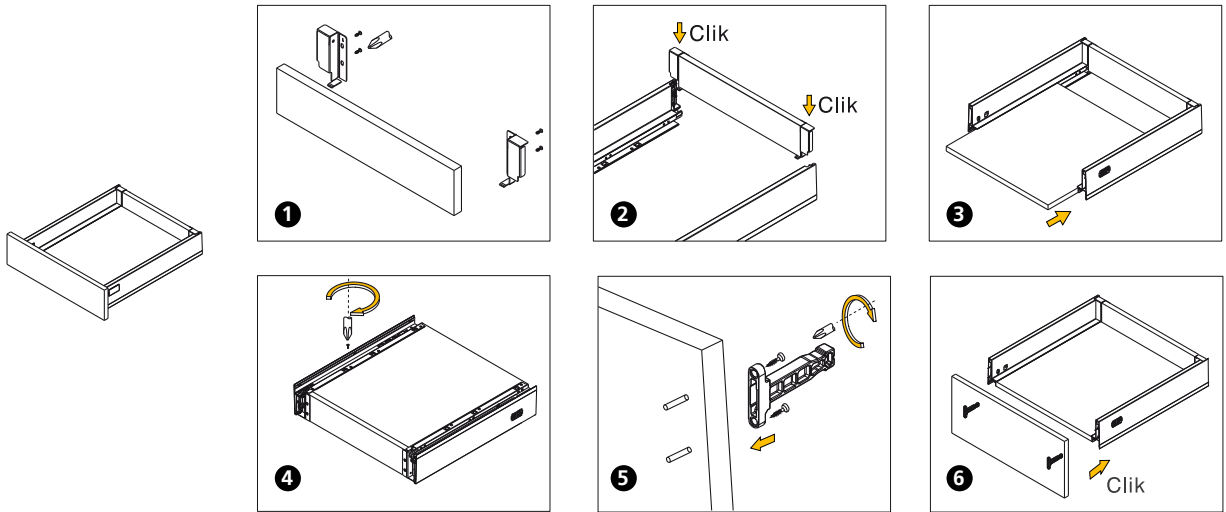

H= 80mm

H= 95mm

H= 127mm

H= 178mm

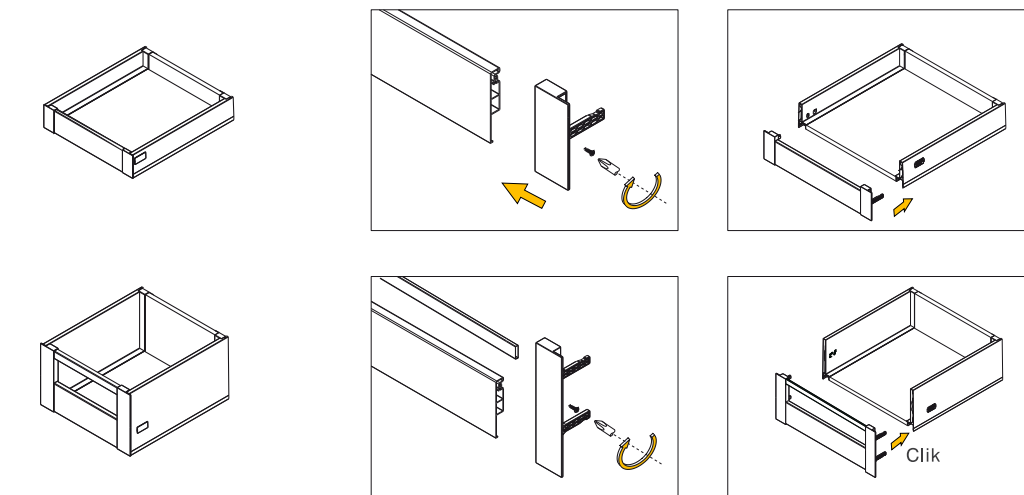

ADJUSTAMENT - REGOLAZIONE - REGULACIÓN - RÉGLAGE - REGULAÇÃO - REGULACJA

H= 80mm

H= 95mm

H= 127mm

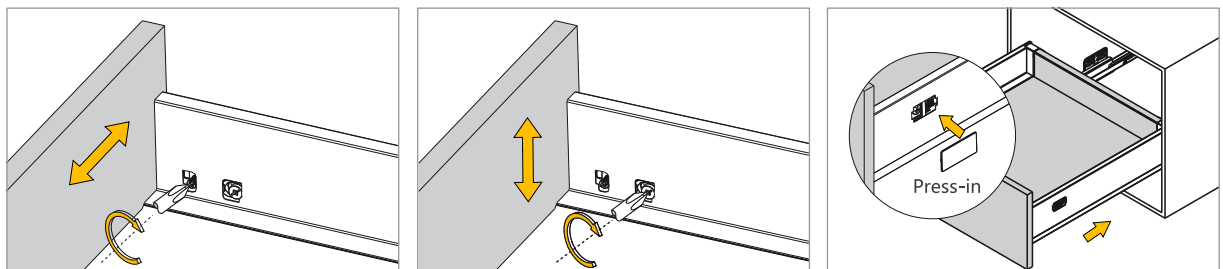

H= 178mm

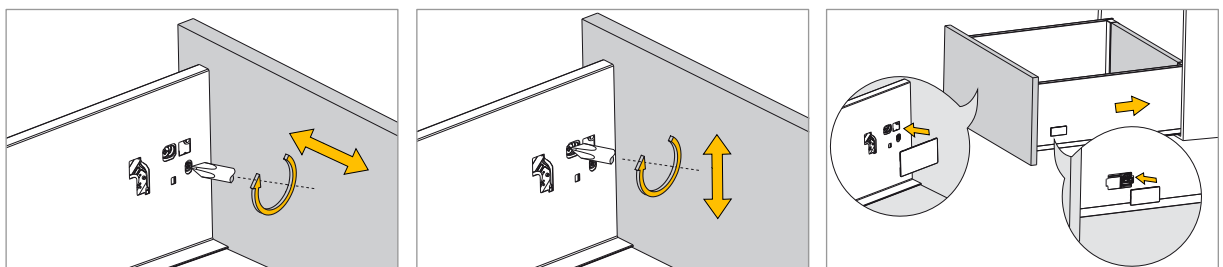

DRAWER / CASSETTO / CAJÓN / TIROIR / GAVETA / SZUFLADA

DISMOUNTING - SMONTAGGIO - DESMONTAJE - DÉMONTAGE - DESMONTAGEM - DO DEMONTAŻU

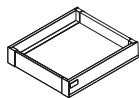
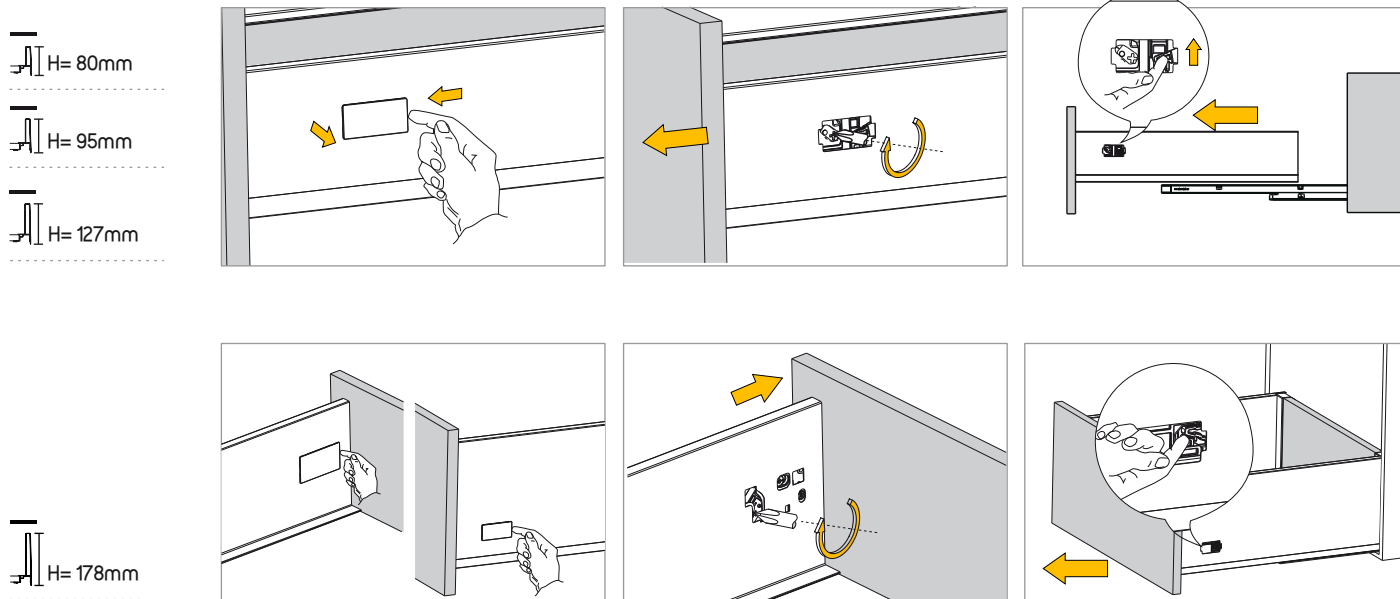

INNER DRAWER - CASSETTO INTERNO - CAJÓN INTERIOR - TIROIR INTÉRIEUR - GAVETA INTERIOR - SZUFLADY WEWNĘTRZNEJ

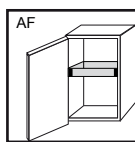

Aluminium front  
Frontalini in alluminio  
Frente de aluminio  
Façade en aluminium  
Frente de alumínio  
Front aluminiumowy

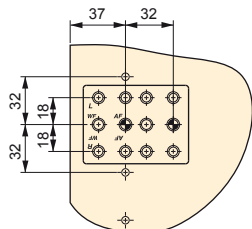

Left side  
Lato sinistro  
Lado izquierdo  
Côté gauche  
Lato esquerda  
Lewa strona

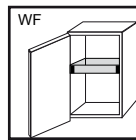
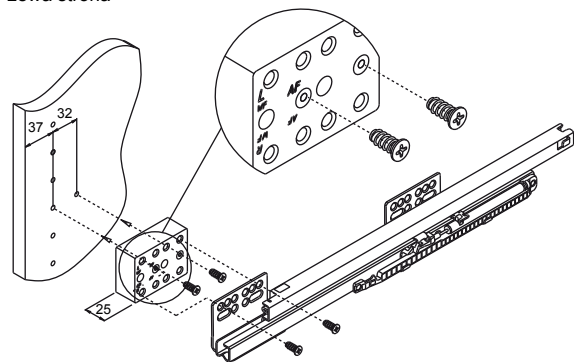

Wood front  
Frontalini in Legno  
Frente de madera  
Façade en bois  
Frente de madeira  
Front drewniany

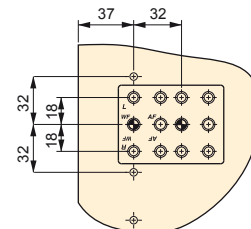

Left side  
Lato sinistro  
Lado izquierdo  
Côté gauche  
Lato esquerda  
Lewa strona

